

Instructions for Installation and Use

Build-in Electric
double oven

GB

English, 2

BD62SS/2
BD52B/2
BD52K/2
BD52P/2
DQ47I/2
DE47X/2

Contents

Introduction,	2
Safety Information,	3
The main parts of your Double Oven (BD62SS/2 & BD52B/2 - BD52K/2 - BD52P/2),	4
The main parts of your Double Oven (DQ47I/2 & DE47X/2),	5
Temperature Conversion Chart,	6
Controls (BD62SS/2 & BD52B/2 - BD52K/2 - BD52P/2),	7
Controls (DQ47I/2 & DE47X/2),	8
Multifunction Selection Switch (BD62SS/2 & BD52B/2 - BD52K/2 - BD52P/2),	9
The electronic programmer,	10
Grill Pan and Handle,	11
Operation when using the Top Oven for Grilling,	12
Using the Top Oven for Solarplus Grilling,	13
Using the Top Oven as a Convection Oven,	14
Operation when using the Top Oven as a Convection Oven,	15
Oven Temperature Charts,	16-17
Main Oven - Fan Grilling (BD62SS/2 & BD52B/2 - BD52K/2 - BD52P/2),	18
Main Oven - Fan Grilling Roasting Chart (BD62SS/2 & BD52B/2 - BD52K/2 - BD52P/2),	19
Using the Main Oven for Other Functions,	20
Main Oven - Conventional Oven (BD62SS/2 & BD52B/2 - BD52K/2 - BD52P/2),	21
Main Oven - Fan Oven (all Models),	22
Main Oven - Fan Oven Cookery Notes,	23-24
Main Oven Temperature Chart,	25-26
Main Oven - Circulaire Roasting (BD62SS/2 & BD52B/2 - BD52K/2 - BD52P/2),	27
Main Oven - Circulaire Roasting Chart (BD62SS/2 & BD52B/2 - BD52K/2 - BD52P/2),	28
Using the Main Oven for Other Functions,	29
Main Oven Grilling (BD62SS/2 & BD52B/2 - BD52K/2 - BD52P/2),	30
Care and Cleaning,	31-32
Care and Cleaning (BD62SS/2 & BD52B/2 - BD52K/2 - BD52P/2),	33
Care and Cleaning (DQ47I/2 & DE47X/2),	34
Installation,	35
Tall Cabinet Ventilation,	36-37
If something goes wrong...,	38-40
Guarantee Information,	41
Service Information,	42

GB

Introduction

GB

To the Installer:

Before installation, fill in the product details on the back cover of this book.
The information can be found on the rating plate.

To the User:

You must read the instructions prior to installing and using the appliance and then retain them for future reference.

! Before operating your new appliance please read this instruction booklet carefully. It contains important information concerning the safe operation, installation and maintenance of the appliance.

! Please keep these operating instructions for future reference. Pass them on to possible new owners of the appliance.

Retention of this Instruction Book

This Instruction Book must be kept handy for reference as it contains important details on the safe and proper use of the appliance.

If you sell or pass the appliance to someone else, or move house and leave it behind, make sure this Book is also provided so the new owner can become familiar with the appliance and safety warnings.

Your new appliance is guaranteed* and will give lasting service. This guarantee is only applicable if the appliance has been installed in accordance with the installation instructions detailed in this booklet. To help make best use of your cooking equipment, please read this booklet carefully.
The appliance is designed specifically for domestic use and responsibility will not be accepted for use in any other installation.

When the cooker is first used an odour may be emitted, this will cease after a period of use

To help remove the 'new' smell, heat up the empty ovens to maximum temperature for a minimum of two or three hours, keeping the oven doors closed. Ensure that the room is well ventilated (e.g. open a window or use an extractor fan) and that persons who may be sensitive to the odour avoid any fumes. It is suggested that any pets be removed from the room until the smell has ceased.

This odour is due to temporary finish on oven liners and elements and also any moisture absorbed by the insulation.

* The guarantee is subject to the provisions that the appliance:

- (a) Has been used solely in accordance with the Users Instruction Book.
- (b) Has been properly connected to a suitable supply voltage as stated on the rating plate attached to this equipment.
- (c) Has not been subjected to misuse or accident or been modified or repaired by any person other than the authorised employee or agent.
- (d) Has been correctly installed.



This appliance conforms to the following EEC directives:

Electromagnetic Compatibility;

- 89/336/EEC
- 92/31/EEC
- 93/68/EEC

Low Voltage Equipment

- 2006/95/EEC
- 93/68/EEC

Technical Characteristics

Top Oven

Usable Volume: 32 Litres

ENERGY LABEL - Top Oven

Directive 2002/40/EC on the label of electric ovens
Norm EN 50304
Declared energy consumption for
Natural convection Class

heating mode: Conventional

Main Oven

Usable Volume: 65 Litres
and 68 Litres for DQ47I/2 and DE47X/2

ENERGY LABEL - Main Oven

Directive 2002/40/EC on the label of electric ovens
Norm EN 50304
Declared energy consumption for
Natural convection Class

heating mode: Fan Oven 

Voltage and Frequency

230-240V~ 50Hz

When used properly your appliance is completely safe but as with any electrical product there are certain precautions that must be observed. PLEASE READ THE PRECAUTIONS BELOW BEFORE USING YOUR APPLIANCE.

Always

- Always make sure you remove all packaging and literature from inside the oven and grill compartments before switching on for the first time.
- Always make sure you understand the controls prior to using the appliance.
- Always keep children away from the appliance when in use as the surfaces will get extremely hot during and after cooking.
- Always make sure all controls are turned off when you have finished cooking and when not in use.
- Always stand back when opening an oven door to allow any build up of steam or heat to disperse.
- Always use dry, good quality oven gloves when removing items from the oven/grill.
- Always take care to avoid heat/steam burns when operating the controls.
- Always turn off the electricity supply at the wall switch before cleaning and allow the appliance to cool.
- Always make sure the shelves are in the correct position before switching on the oven.
- Always keep the oven and grill doors closed when the appliance is not in use.
- Always take care when removing utensils from the top oven when the main oven is in use as the contents may be hot.
- Always keep the appliance clean as a build up of grease or fat from cooking can cause a fire.
- Always follow the basic principles of food handling and hygiene to prevent the possibility of bacterial growth.
- Always keep ventilation slots clear of obstructions.
- Always refer servicing to a qualified appliance service engineer.
- During use the oven becomes hot. Care should be taken to avoid touching heating elements inside the oven.

SAFETY ADVICE

IN THE EVENT OF A CHIP PAN OR ANY OTHER PAN FIRE:

1. TURN OFF THE COOKER APPLIANCE AT THE WALL SWITCH.

2. COVER THE PAN WITH A FIRE BLANKET OR DAMP CLOTH, this will smother the flames and extinguish the fire.
3. LEAVE THE PAN TO COOL FOR AT LEAST 60 MINUTES BEFORE MOVING IT. Injuries are often caused by picking up a hot pan and rushing outside with it. NEVER USE A FIRE EXTINGUISHER TO PUT OUT A PAN FIRE as the force of the extinguisher is likely to tip the pan over. Never use water to extinguish oil or fat fires.

Never

- Never leave children unsupervised where a cooking appliance is installed as all cooking surfaces will be hot during and after use.
- Never allow anyone to sit or stand on any part of the appliance.
- Never store items above the appliance that children may attempt to reach.
- Never remove the oven shelves whilst the oven is hot.
- Never heat up unopened food containers as pressure can build up causing the container to burst.
- Never store chemicals, food stuffs or pressurised containers in or on the appliance, or in cabinets immediately above or next to the appliance.
- Never operate the grill with the door closed as this will cause the appliance to overheat.
- Never use the appliance as a room heater.
- Never use the grill to warm plates.
- Never dry any items on the oven doors.
- Never install the appliance next to curtains or other soft furnishings.
- Never allow children to play with the appliance controls.
- Never use 'steam cleaners'.

This appliance is not intended for use by persons (including children) with reduced physical, sensory or mental capabilities, or lack of experience and knowledge, unless they have been given supervision or instruction concerning use of the appliance by a person responsible for their safety.

Children should be supervised to ensure that they do not play with the appliance.

! The appliance should not be operated by people (including children) with reduced physical, sensory or mental capacities, by inexperienced individuals or by anyone who is not familiar with the product. These individuals should, at the very least, be supervised by someone who assumes responsibility for their safety or receive preliminary instructions relating to the operation of the appliance.

The main parts of your Double Oven

GB

(BD62SS/2 & BD52B/2 - BD52K/2 - BD52P/2)

WARNING: DO NOT TOUCH THE GLASS DOORS WHEN THE OVEN IS IN USE AS THESE AREAS CAN BECOME HOT.

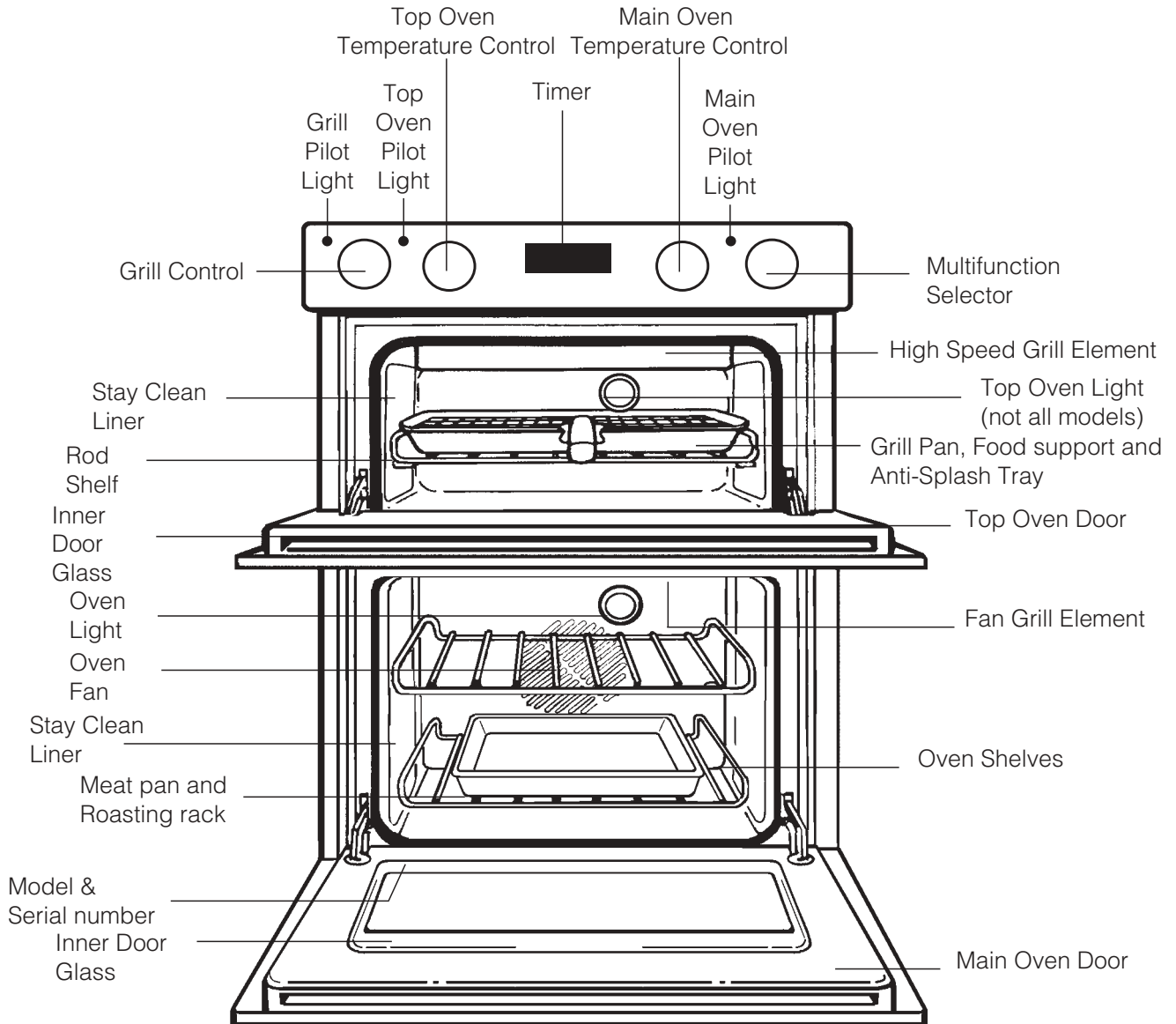

NEVER line the shelves, floor or sides of the oven or grill with aluminium foil as overheating and damage may result.

The main parts of your Double Oven

(DQ47I/2 & DE47X/2)

WARNING: DO NOT TOUCH THE GLASS DOORS WHEN THE OVEN IS IN USE AS THESE AREAS CAN BECOME HOT.

GB

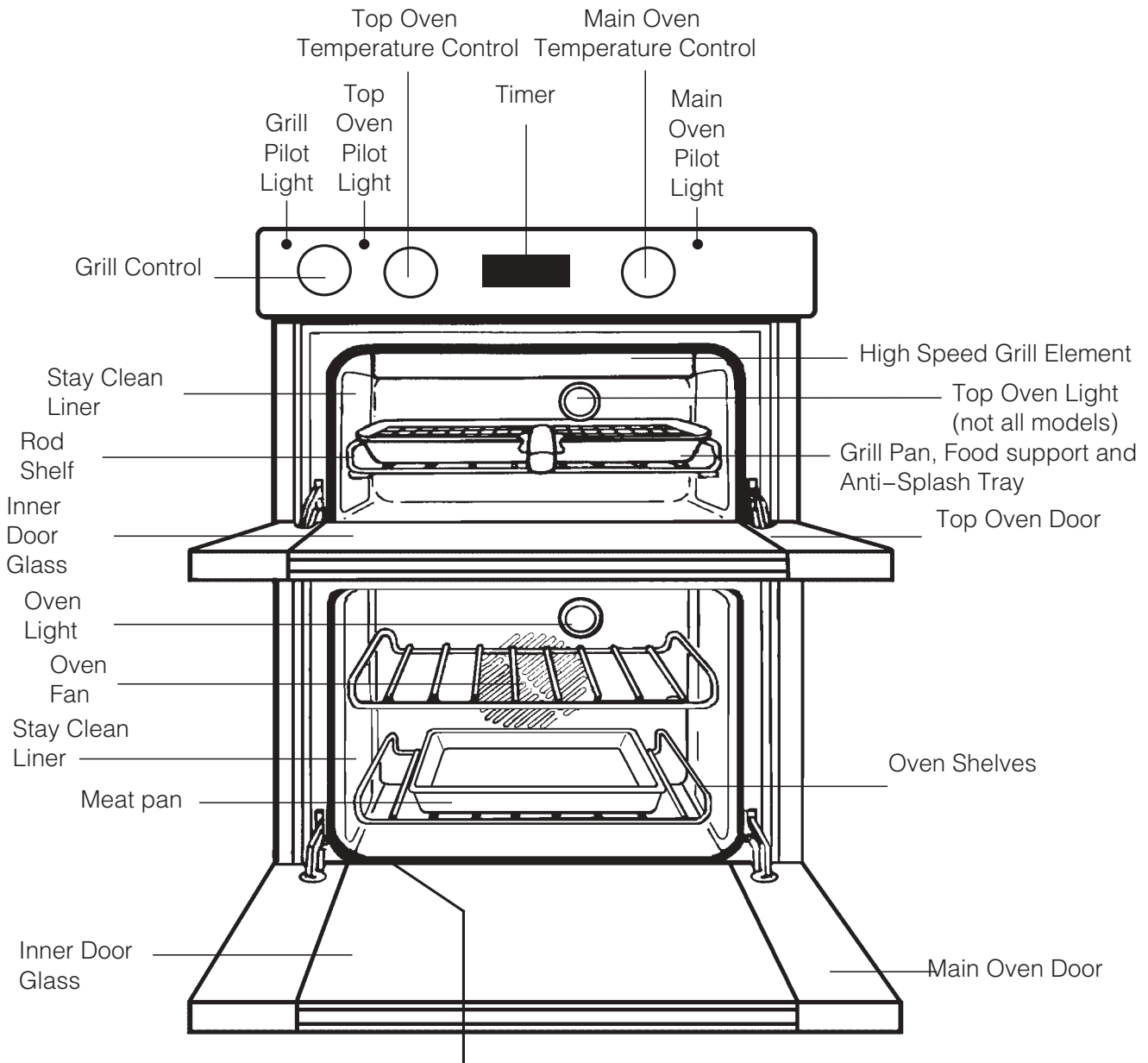

MODEL & SERIAL NUMBER LABEL –
Record the Model No. and the Serial No.
on back page.

NEVER line the shelves, floor or sides of the oven or grill with aluminium foil as overheating and damage may result.

Temperature Conversion Chart

GB

The chart below gives details of comparisons of oven settings for gas conventional ovens and fan oven in degrees °F and °C

Gas Mark	Conventional Oven		Fan Oven
	°F	°C	°C
½	250	120	100
1	275	140	120
2	300	150	130
3	325	160	140
4	350	180	160
5	375	190	170
6	400	200	180
7	425	220	200
8	450	230	210
9	475	240	220

(BD62SS/2 & BD52B/2 - BD52K/2 - BD52P/2)

GB

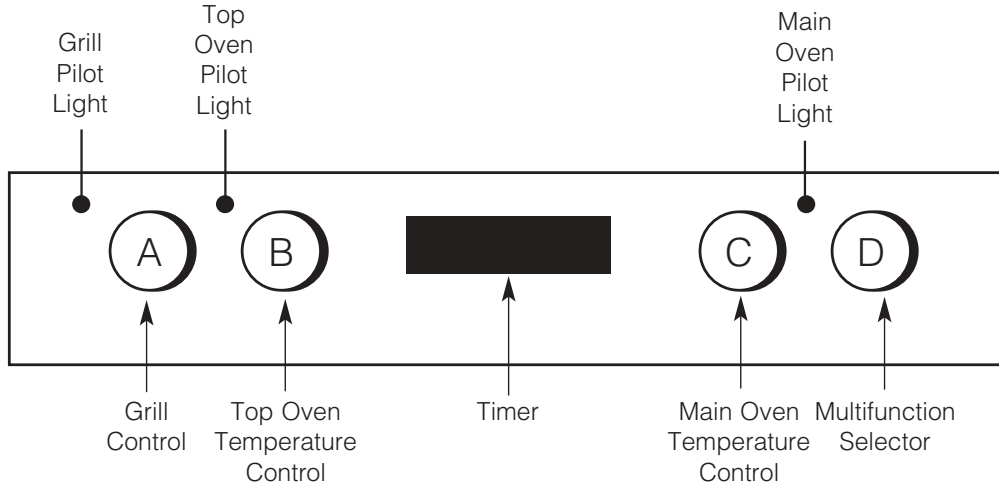

IMPORTANT

Before using your oven in the ordinary way, ALWAYS make sure that the timer has been set to MANUAL operation. Unless this is done, the main oven cannot heat up. Before seeking assistance, make sure this is done (refer to oven timer operation).

MULTIFUNCTION SELECTOR

Rotate the control knob in either direction to the required function. Many of the functions will also require the main oven thermostat to be set before the oven will heat up.

MAIN OVEN TEMPERATURE CONTROL

This is used in addition to the multifunction selector. This is used for the functions: fan oven, fan grill, half grill and full grill and conventional oven. Turn the control clockwise to set the oven thermostat to the required temperature. If the timer is set correctly and the selector switch set to a suitable function an indicator light will illuminate. This will remain on until the oven reaches the required temperature. This light will then cycle on and off as the thermostat maintains control of the oven temperature.

TOP OVEN TEMPERATURE CONTROL

Turn the control clockwise to set the top oven thermostat to the required temperature. An indicator light will illuminate. This will remain on until the oven reaches the required temperature. This light will then cycle on and off as the thermostat maintains control of the oven thermostat.

GRILL CONTROL

The grill control is designed to provide variable heat control of either both grill elements on together or the single left-hand grill element only. To set the grill power turn the grill control to any setting MIN (1) - MAX (4), clockwise for FULL grill and anti-clockwise for HALF grill.

COOLING FAN

A gentle flow of air will be blown below the control panel when the grill control is used and after a short period of time when the ovens are used. Note: Whenever the appliance has been used, the cooling fan may run on or restart itself after all the controls have been turned off. This indicates that the appliance is still warm.

The Controls

GB

(DQ47I/2 & DE47X/2)

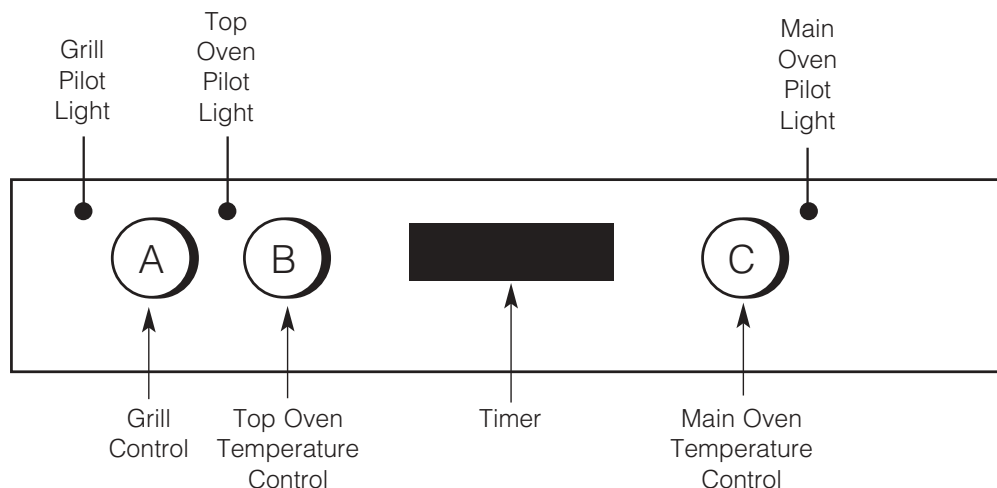

IMPORTANT

Before using your oven in the ordinary way, ALWAYS make sure that the timer has been set to MANUAL operation. Unless this is done, the main oven cannot heat up. Before seeking assistance, make sure this is done (refer to oven timer operation).

MAIN OVEN TEMPERATURE CONTROL

Turn the control clockwise to set the oven thermostat to the required temperature.

If the timer is set correctly an indicator light will illuminate. This will remain on until the oven reaches the required temperature. This light will then cycle on and off as the thermostat maintains control of the oven temperature.

TOP OVEN TEMPERATURE CONTROL

Turn the control clockwise to set the top oven thermostat to the required temperature. An indicator light will illuminate. This will remain on until the oven reaches the required temperature. This light will then cycle on and off as the thermostat maintains control of the oven thermostat.

GRILL CONTROL

The grill control is designed to provide variable heat control of either both grill elements on together or the single left-hand grill element only.

To set the grill power turn the grill control to any setting MIN - MAX, clockwise for FULL grill and anti-clockwise for HALF grill.

COOLING FAN

A gentle flow of air will be blown below the control panel when the grill control is used and after a short period of time when the ovens are used.

Note: Whenever the appliance has been used, the cooling fan may run on or restart itself after all the controls have been turned off. This indicates that the appliance is still warm.

(BD62SS/2 & BD52B/2 - BD52K/2 - BD52P/2)

The Multifunction selector switch is used when operating the main oven.

With the exception of the O position the main oven light will remain on when this selector switch is used.

Off

With the selector in this position the main oven will not heat up. The timer will still operate.

Fan Oven

The oven fan and a rear element are controlled when this function is selected.

Use the main oven thermostat control to set the required temperature.

Conventional Oven

Top and base elements are controlled when this function is selected.

Use the main oven thermostat to set the required temperature.

Half Grill

With this function selected only the left hand side of the grill will be on.

Use the oven thermostat control to set the required temperature.

Oven door must be open for grilling.

Full Grill

Both left and right hand grill elements will be on in this position.

Use the oven thermostat control to set the required temperature.

Oven door must be open for grilling.

Fan Grill

The oven fan and fan grill element are controlled when this function is selected.

Use the oven thermostat control to set the required temperature.

Oven door must be closed for fan grilling.

Fan Only

The oven fan will operate when this function is selected.

The oven thermostat control must be set in the off position.

Light Only

This function switches on the oven light only.

The electronic programmer

GB

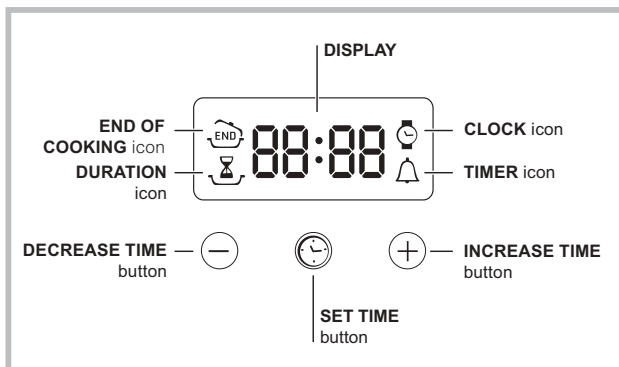





! The Top Oven and Main Oven can be controlled by the automatic timer. When the timer control has been set for one oven, it is possible to use the other oven only during the same automatic cooking programme.
! NEVER operate the grill when the ovens are set to cook automatically because the oven cavity can become warm and this may cause bacterial growth in food.

Setting the clock

! The clock may be set when the oven is switched off or when it is switched on, provided that a the end time of a cooking cycle has not been programmed previously.



After the appliance has been connected to the mains,

or after a blackout, the  icon and the four numerical digits on the DISPLAY will begin to flash.

1. Press the  button several times until the  icon and the four digits on the display begin to flash.
2. Use the “+” and “-” buttons to adjust the time; if you press and hold either button, the display will scroll through the values more quickly, making it quicker and easier to set the desired value.
3. Wait for 10 seconds or press the  button again to finalise the setting.

Setting the timer

! This function does not interrupt cooking and does not affect the oven; it is simply used to activate the buzzer when the set amount of time has elapsed.



1. Press the  button several times until the  icon and the three digits on the display begin to flash.
2. Use the “+” and “-” buttons to set the desired time; if you press and hold either button, the display will scroll through the values more quickly, making it quicker and easier to set the value.
3. Wait for 10 seconds or press the  button again to finalise the setting.

The display will then show the time as it counts down. When this period of time has elapsed the buzzer will be activated.

Programming cooking





! A cooking mode must be selected before programming can take place.

Programming the cooking duration

1. Press the  button several times until the  icon and the three digits on the DISPLAY begin to flash.
2. Use the “+” and “-” buttons to set the desired duration; if you press and hold either button, the display will scroll through the values more quickly, making it quicker and easier to set the value.
3. Wait for 10 seconds or press the  button again to finalise the setting.
4. When the set time has elapsed, the text END appears on the DISPLAY, the oven will stop cooking and a buzzer sounds. Press any button to stop it.
 - For example: it is 9:00 a.m. and a time of 1 hour and 15 minutes is programmed. The programme will stop automatically at 10:15 a.m.

Setting the end time for a cooking mode

! A cooking duration must be set before the cooking end time can be scheduled.

1. Follow steps 1 to 3 to set the duration as detailed above.
2. Next, press the  button until the  icon and the four digits on the DISPLAY begin to flash.
3. use the “+” and “-” buttons to adjust the cooking end time; if you press and hold either button, the display will scroll through the values more quickly, making it quicker and easier to set the desired value.
4. Wait for 10 seconds or press the  button again to finalise the setting.
5. When the set time has elapsed, the text END appears on the DISPLAY, the oven will stop cooking and a buzzer sounds. Press any button to stop it. Programming has been set when the  and  buttons are illuminated. The DISPLAY shows the cooking end time and the cooking duration alternately.
 - For example: It is 9:00 a.m. and a duration of 1 hour has been programmed. 12:30 is scheduled as the end time. The programme will start automatically at 11:30 a.m.

Cancelling a programme

To cancel a programme:

- press the  button until the icon corresponding to the setting you wish to cancel and the digits on the display are no longer flashing. Press the “-” button until the digits 00:00 appear on the display.
- Press and hold the “+” and “-” buttons; this will cancel all the settings selected previously, including timer settings.

Grill Pan and Handle

Using the grill pan kit

The grill pan handle is detachable from the pan to facilitate cleaning and storage. Fix the pan handle securely before use:

1. Fit the handle to the grill pan so the external 'hooks' embrace the that edge of the pan (fig. 1)
2. Make sure that the middle part of the handle fits exactly the protruding support of the pan (fig .2) and holds the pan from the bottom.

The food must be placed on the rack in the grill pan. Position the grill pan on top of the oven rack. The best results are achieved by placing the oven rack on the uppermost shelves. Pouring a little water into the grill pan will make the collection of grease particles more efficient and prevent the formation of smoke.

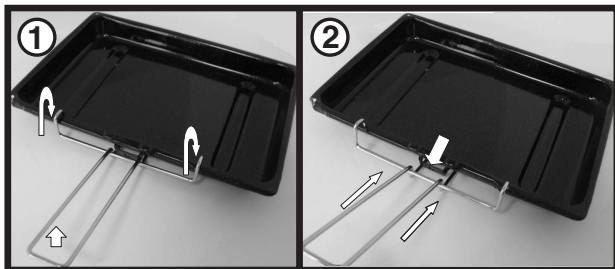

Grill Pan, Food Support and Anti-Splash Tray

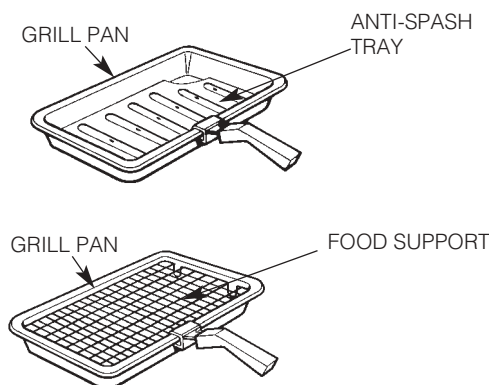

Note: To stop fat splashing onto the grill mesh, it is important to use the ant-splash tray as shown in the grilling chart. Always clean the grill pan, anti-splash tray and food support after each use.

Top Oven Shelf Positioning for Grilling

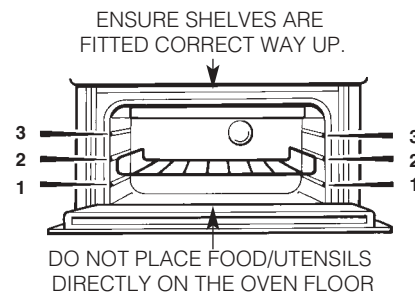

NOTE:

- Preheat the grill if indicated on grill chart.
- The grill pan must be placed on the correct shelf and positioned centrally under the grill element.
- Leave the control at MAX for toast, and for fast cooking of foods.
- For thicker foods requiring longer cooking, turn the switch to a lower setting after the initial sealing on both sides at MAX. The thicker the food, the lower the control should be set.
- DO NOT line the grill pan with aluminium foil, as this increases the amount of fat spitting which can cause a fire.
- After use always return the grill control to the OFF (0) position.

Operation when using the Top Oven for Grilling

GB

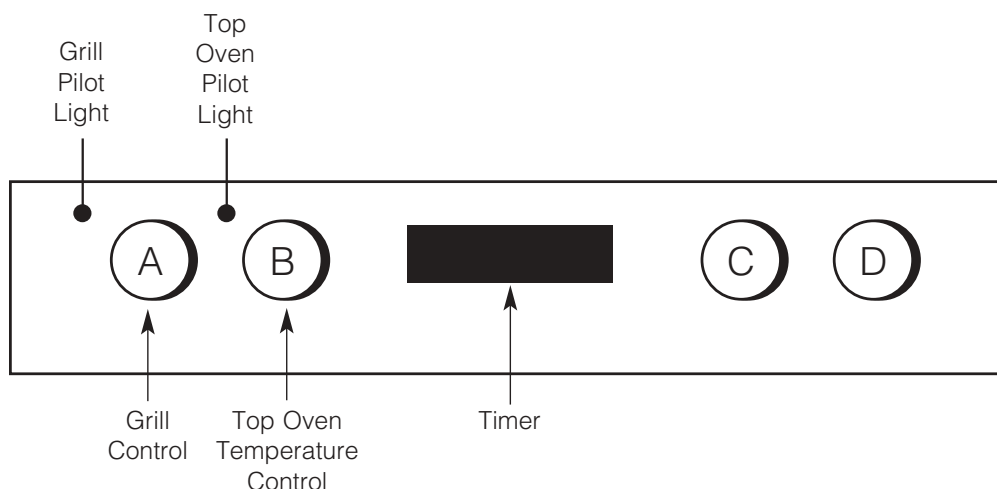

Step 1 Ensure oven timer is set to manual. Place the shelf in the correct position (see Grilling Guide). Place the food/grill pan on the shelf, positioned centrally under the grill element. Leave the top oven door fully open.

Step 2 Turn knob (A), clockwise for FULL grill or anti-clockwise for HALF grill, to select the grill setting MIN (1) – MAX (4). NOTE: MIN (1) = Low, MAX (4) = High.

Grill Controls Example:

4 or MAX = High Grill Setting (depending on model)

NOTE: Do not grill with the grill/top oven door closed.

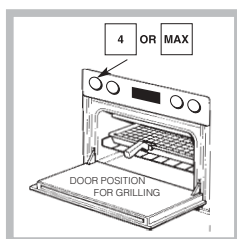

Step 3 After use, turn the grill control (A) to the off position (0).

! The Grill Pilot Light is lit when grill is used.

! Ensure knob (B) is in "0 position". The grill and the top oven cannot work simultaneously

DO NOT allow young children near to the appliance when the grill is in use as the surfaces get extremely hot.

Using the Top Oven for Solarplus Grilling

Your cooker is not fitted with a conventional grill. Hotpoint have developed a Solarplus high speed grill which is designed to reduce your grilling times. It is quicker because it takes less time to warm up from cold. Conventional grills require 5 minutes pre-heat before food can be placed beneath them, but for normal grilling the Solarplus grill can be used directly from cold without any pre-heat. However, when toasting, optimum performance is achieved by pre-heating the grill for about 1 minute.

NOTE: You will notice that the grill elements are protected by a wire mesh. This stops you from touching live parts.

DO NOT under any circumstances insert objects into the grill mesh as this could damage the element wire, break the glass tubes or if the grill is on, cause electric shock.

During use, the wire mesh may become soiled. DO NOT attempt to clean it while the grill is still on. Turn off at the control and allow to cool before cleaning. Care must be taken to ensure the grill mesh is not distorted - do not store the grill pan handle on the food grid when the shelf is in the highest position.

IMPORTANT:
Grilling should never be undertaken with the grill/top oven door closed.

Guide to Solarplus Grilling

FOOD		PREHEAT FOR ONE MINUTE	SHELF POSITION FROM THE BASE OF THE OVEN	SETTING	APPROXIMATE COOKING TIME	PAN TO BE USED
Toasting of Bread Products		Setting MAX	3 or 2	Setting MAX (4)	3 - 5 minutes	Grill pan and food support
Small cuts of meat, Sausage, Bacon		None	3 or 2	Setting MAX (4) for 4 minutes then reduce to lower setting	10 - 15 minutes	Grill pan, antispash tray and food support
Chops etc. Gammon steaks		None	2	Setting MAX (4) for 6-8 minutes then reduce to lower setting	25 - 30 minutes	Grill pan, antispash tray and food support
Fish:	Whole	None	2	Setting MAX (4)	6 - 8 minutes	Grill pan and food support
	Filletts	None	3		10 - 15 minutes	
	Fingers	None	3		10 - 15 minutes	
Pre-cooked potato products		None	3 or 2	Setting between MEDIUM (2) and MAX (4) position	10 - 12 minutes	Grill pan and food support
Pizzas		None	3 or 2	Setting between MEDIUM (2) and MAX (4) position	10 - 12 minutes	Grill pan and food support
Browning of food eg. Cauliflower Cheese		Setting MAX	3 or 2	Setting MAX (4)	5 - 10 minutes	Dish placed directly on the shelf

Using the Top Oven as a Convection Oven

GB

The top oven should be used to cook small quantities of food. The oven is designed so that the grill element operates at a reduced heat output, this is combined with a heating element situated underneath the floor of the oven. To ensure even cooking of the food it is important that cooking utensils are positioned correctly on the oven shelf so that the element is directly above. As a guide, the front of the utensil should be approx. 100mm (4") from the front of the shelf.

Note: Charts are a guide only, to suit personal taste and requirements, it may be necessary to increase or decrease temperatures by 10°C. It may also be necessary to increase or decrease cooking times.

SHELF POSITIONING

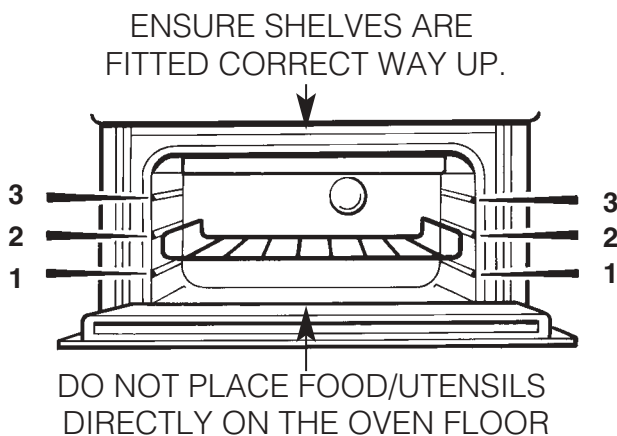

There should always be at least 25mm (1 inch) between the top of the food and the grill element.

WARNING: Items stored in the top oven will get hot when the main oven is in use.

DO NOT allow young children near to the appliance when the top oven is in use as the surfaces get extremely hot.

Operation when using the Top Oven as a Convection Oven

 Hotpoint

GB

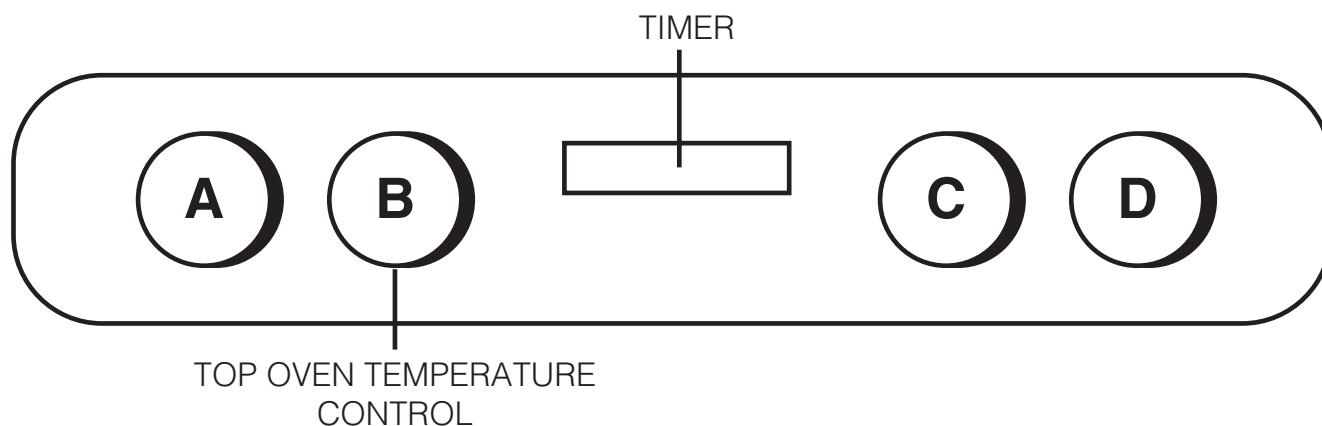

- Step 1** Check that the timer is in manual.
- Step 2** Place the shelf in the correct position (see Oven Temperature Charts).
- Step 3** Select the required cooking temperature (100°C-MAX) using control (B) (see Top Oven Temperature Charts). The pilot light (·) will immediately come on, and remain on until the oven reaches the required temperature. The light will then automatically go off and on during cooking as the oven thermostat maintains the correct temperature.
- Step 4** Place the food on the shelf directly below the element ensuring the oven door is closed.

NOTE: At the end of your cooking, always return control (B) to the OFF (O) position.

PLATE WARMING

Place the plates/dishes on shelf position 1 from the base of the top oven, and turn top oven temperature control (B) to 100°C for 10-15 minutes.

Never use the grill setting control (A) when warming plates.

TOP OVEN UTENSILS

Do Not use: Meat Pans and Baking Trays larger than – 225mm x 300mm (9"x12")

DO NOT use the grill pan or main oven meat pan as a meat pan in the top oven, as the air circulation will be seriously restricted.

Oven Temperature Charts - Baking

GB

	Top Oven Cooking			
Baking	Pre-heat	Temperature °C	Time in mins.	Position in Oven
Scones	Yes	210/220	10-15	Runner 2 from bottom of oven
Small Cakes	Yes	180/190	20-25	Runner 2 from bottom of oven
Victoria Sandwich	Yes	170/180	20-30	Runner 2 from bottom of oven
Sponge Sandwich (fatless)	Yes	180/190	20-25	Runner 2 from bottom of oven
Swiss Roll	Yes	200/210	10-15	Runner 2 from bottom of oven
Semi-rich Fruit cakes	Yes	150/160	60-75 7 inch	Runner 2 from bottom of oven
Rich Fruit Cakes	Yes	140/150	Time Dependent on size	Runner 1 or 2 from bottom of oven
Shortcrust Pastry	Yes	190/200	Time Dependent on recipe	Runner 1 from bottom of oven
Puff Pastry	Yes	200/210	Time Dependent on recipe	Runner 1 from bottom of oven
Yorkshire Pudding	Yes	190/200	30-40	Runner 1 or 2 from bottom of oven
Individual Yorkshire Pudding	Yes	200/210	20-30	Runner 1 from bottom of oven
Milk Pudding	Yes	140/150	90-120	Runner 1 from bottom of oven
Baked Custard	Yes	150/160	40-50	Runner 1 from bottom of oven
Bread	Yes	200/210	30-45	Runner 1 from bottom of oven
Meringues	Yes	100	150-180	Runner 2 from bottom of oven

	Fan Oven Cooking		
Baking	Pre-heat	Temperature °C	Time in mins.
Scones	Yes	210/220	9-12
Small Cakes	No	170/180	15-20
Victoria Sandwich	No	160/170	20-25
Sponge Sandwich (fatless)	Yes	190/200	15-20
Swiss Roll	Yes	190/200	10-15
Semi-rich Fruit cakes	No	140/150	1¼ - 1½ hrs
Rich Fruit Cakes	No	130/140	Depending on size
Shortcrust Pastry	No	190/200	Depending on size
Puff Pastry	No	190/200	Depending on size
Yorkshire Pudding	Yes	180/190	40-45
Individual Yorkshire Pudding	Yes	190/200	20-25
Milk Pudding	No	130/140	1½ - 2 hrs
Baked Custard	No	140/150	35-45
Bread	Yes	200/210	30-35
Meringues	No	80-90	3 - 4 hrs

Note: If soft margarine is used for cake making, temperatures recommended by the manufacturers should be followed. Temperatures recommended in this chart refer to cakes made with block margarine only.

Oven Temperature Charts - Meat

Top Oven Cooking				
Meat	Pre-heat	Temperature °C	Time (approx.)	Position in Oven
Beef/ Lamb (slow roasting)	Yes	170/180	35 mins per 450g (1lb) + 35 mins over.	Runner 1 from bottom of oven.
Beef/ Lamb (foil covered)	Yes	190/200	35-40 mins per 450g (1lb)	
Pork (slow roasting)	Yes	170/180	40 mins per 450g (1lb) + 40 mins over	
Pork (foil covered)	Yes	190/200	40 mins per 450g (1lb)	
Veal (slow roasting)	Yes	170/180	40-45 mins per 450g (1lb) + 40 mins over	
Veal (foil covered)	Yes	190/200	40-45 mins per 450g (1lb)	
Poultry/Game (slow roasting)	Yes	170/180	25-30 mins per 450g (1lb) + 25 mins over	
Poultry/Game (foil covered)	Yes	190/200	25-30 mins per 450g (1lb)	
Casserole Cooking	Yes	150	2-2½ hrs	

If using aluminium foil, never:
 1.Allow foil to touch sides of oven. 2.Cover oven interior with foil. 3.Cover shelves with foil.

Top Oven Cooking			
Meat	Pre-heat	Temperature °C	Time (approx.)
Beef	No	160/180	20-25 mins per 450g (1lb) + 20 mins extra.
Lamb	No	160/180	20-30 mins per 450g (1lb) +25 mins extra.
Pork	No	160/180	25-30 mins per 450g (1lb) +25 mins extra.
Veal	No	160/170	25-30 mins per 450g (1lb) +25 mins extra.
Chicken/Turkey up to 4kg (8lb)	No	160/180	18-20 mins per 450g (1lb) + 20 mins extra.
Turkey 4 to 5.5kg (8 to 12lb) over 5.5kg (12lb)	No	150/160	13-15 mins per 450g (1lb) at 150/160°C allow 12 mins per 450g at 150°C
Casserole Cooking	No	140-150	1½ - 2 hrs

If using aluminium foil, never:
 1.Allow foil to touch sides of oven. 2.Cover oven interior with foil. 3.Cover shelves with foil.

The most accurate method of testing the readiness of joints of meat or whole poultry is to insert a meat thermometer into the thickest part of a joint, or the thickest part of poultry thighs, during the cooking period. The meat thermometer will indicate when the required internal temp has been reached.

Beef - Rare: 60°C **Lamb:** 80°C **Poultry:** 90°C
 Medium: 70°C **Pork:** 90°C
 Well Done: 75°C **Veal:** 75°C

Main Oven - Fan Grilling

GB

(BD62SS/2 & BD52B/2 - BD52K/2 - BD52P/2)

Fan grilling is a combination of heat from the grill element and the oven fan circulating the hot air around the food.

Joints of meat and poultry will be browned as if they were cooked on a rotisserie or spit but more economically as the door left closed.

If required, fan grilling can be timed using the Oven Auto timer.

Follow the timer instructions before selecting fan grill and the required temperature.

If Manual fan grilling is required always ensure the timer is set to Manual.

Operating Instruction

1. Open the oven door.
2. Select the correct shelf position, as stated in chart.
3. Turn the selector switch to the Fan grill position.
4. Turn the oven thermostat control to the required temperature (see Fan Grilling Roasting Chart, next page).
5. Position the meat pan centrally under the grill elements.
6. Close the oven door.
7. After use always return both controls to the off position.
8. If the oven timer was used, reset to Manual.

As with the fan oven cooking there is no need to pre-heat the oven – yet another economy feature. Also you can cook more than one thing at a time – even up to 4 small chickens.

Temperatures

These will be similar to those used for the more traditional form of roasting but the guide will give you an indication of which temperature to set the Thermostat. But remember that because of the way the oven is heated this is a more economical way of roasting.

General Recommendations

Most types of meat and poultry cooked by this method will have an all over brownness and crispness on the outside. The only exceptions are very lean joints, such as veal, which, because of its low fat content, is better cooked using conventional heating.

1. Always place the pan on the shelf position recommended. (See Chart).
2. There is no need to preheat the oven before cooking and all fan grilling should be carried out with the oven door closed, this saves energy. The cooking temperatures and times are calculated from a cold oven.
3. After rinsing and drying meat, place on the food roasting support rack over the pan supplied.
4. Position meat in oven as recommended in the roasting chart.
5. Fan grilling is ideally suited for cooking all types of poultry and larger joints of meat (e.g. stuffed, rolled joints and legs of pork and lamb). Results will be as if you had cooked the food on a rotisserie. If you use frozen meat or poultry it must be completely defrosted before it is cooked.
6. When cooking a joint always grill it with the fat side uppermost in order to crisp it. For bigger joints or where there is little bone, grill at the lower temperature given in the table and cook for a longer time per kg.
7. When cooking any type of poultry, start grilling the underside uppermost and turn breast uppermost about a third to halfway through the cooking period. If cooking stuffed poultry allow slightly longer cooking time.

Meat pan and roasting rack

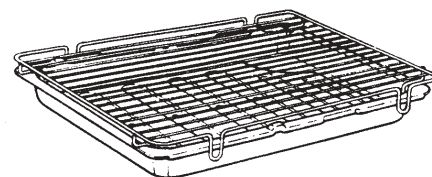

Main Oven - Fan Grilling Roasting Chart



(BD62SS/2 & BD52B/2 - BD52K/2 - BD52P/2)

GB

Shelf positions are counted from the base upwards ie: lowest shelf position is 1.

Type of Meat or Poultry	Weight kg	Temp °C	Time (min/kg)	Plus Extra Time (mins)	Total Cooking Time (mins)	Tips
PORK Pork Chop - thick		170	25		Dependente on size	Season. Grill on shelf position 3. Turn over after 15 mins. Grill on shelf position 3 Turn after 15 mins. Score fat with sharp knife and rub on salt. Pork should always be thoroughly cooked. So overcook rather than undercook. Grill on shelf position 1.
Gammon Steaks		160	30		Dependente on size	
Pork - any type of joint	1.0	160-170	60-70	45	105-120	
	1.5	150-170	60-70	45	130-150	
	2.0	140-150	65-75	50	180-230	
	2.5	140-150	65-75	50	220-240	
	over 2.5	140	70-75	50	-	
LAMB Lamb chop - thick		170	25		Dependent on size	Season. Grill on shelf position 3. Turn over after 15 mins. Score fat. Season with pepper and rosemary. If you prefer the lamb pink choose the shorter time Grill on shelf position 1.
Lamb - any type of joint	1.0	160-170	30-40	45	78-88	
	1.5	160-170	35-40	45	90-110	
	2.0	150-160	35-45	50	120-140	
	2.5	150-160	40-45	50	150-170	
	Over 2.5	150	45-50	50	-	
BEEF Beef - joints which have an outside layer of fat eg. Rib, Rolled, Sirloin	1.0	170-180	40-50	20	60-70	Season. If joint preferred rare grill for the shorter time. If preferred well done grill for the longer time. Grill on shelf position 1.
	1.5	170-180	40-50	20	80-90	
	2.0	160-170	40-50	20	100-110	
	2.5	160-170	45-50	30	140-150	
	over 2.5	160	45-50	40	-	
CHICKEN Chicken joints	1.0	180	30	30	60	Season and brush over with melted butter to give nicely browned skin. Grill on shelf position 1. Shelf 1.
	1.5	180	30	30	75	
	2.0	170	35	30	100	
	2.5	170	35	30	115	
	over 2.5	160-170	40	30	-	
	less than 1kg each	180	30	30	60	
DUCK	1.5	180	30	30	75	Dry thoroughly and lightly salt. Grill on shelf position 1.
	2.0	180	30	30	90	
	2.5	180	35	30	115-130	
GOOSE	up to 4	170-190	40	40	-	Can be stuffed. Grill on shelf position 1
	4-5	160-170	45	40	-	
TURKEY	up to 5	170	-	-	150-165	Season and brush over with melted butter to give nicely browned skin. Grill on shelf position 1.
	6-8	150	-	-	165-175	
GAME Grouse Partridge Pheasant	Any Any Any	170-180 170-180 170-180	30-50 40-50 40-50	- - -	- - -	Well hung meat will require less cooking time. grill on position 1.
Beefburgers	450g(lb)	170	25mins per 450g (lb)			Shelf 3. Shelf 3. Prick sausages before cooking. Shelf 3. Roll up bacon before cooking. 4 pieces of steak, sausages, chops, bacon, tomatoes & mushrooms. Cook sausages, chops, bacon for 10 mins. add steak, cook for further 20 mins.
Sausages	450g(lb)	170	25mins per 450g (lb)			
Bacon	450g(lb)	170	25mins per 450g (lb)			
Mixed Grill		170			30	

Using the Main Oven for Other Functions

GB

FAN ONLY SETTING

DEFROSTING FROZEN MEAT & POULTRY

Joints of meat and whole birds should be defrosted slowly, preferably in a refrigerator (allowing 5-6 hours per lb.) or at room temperature (allowing 2-3 hours per lb.). Frozen meat or poultry must be completely defrosted before cooking in the oven. However, to decrease the amount of time required to defrost food items, a nonheating fan only setting may be selected for the main oven only.

OPERATION: TO ASSIST IN DEFROSTING:

Place food in the oven and close the oven door.
(BD62SS/2 & BD52B/2 - BD52K/2 - BD52P/2) - Turn the Multifunction Control (D) clockwise to the FAN ONLY setting.
(DQ471/2 & DE47X/2) - Turn the Main Oven Control (C) clockwise to the  setting. This defrosts by circulating the air around the food, time to defrost will depend on type and size of the food.

NOTES: DO NOT defrost meat and poultry by warming the food through.

Foods ideally suited to defrosting using the fan only setting are cream/cream cakes, butter cream filled cakes, gateaux, cheese cakes, iced cakes, quiches, pastries, biscuits, bread, croissants, fruit and many delicate frozen foods. If fish, meat and poultry are to be defrosted using the fan only setting, where possible it is recommended that the food should be small and thin.

The items should be placed so that the maximum amount of surface area is exposed to the circulating air, and that they are turned regularly to ensure even defrosting.

Larger cuts of meat and poultry may be defrosted by using the fan only setting up to a maximum weight of 2 kg (4lb 8oz).

It is important to wash both meat and poultry and cooking utensils immediately after defrosting and before cooking. Food should be cooked immediately after defrosting.

It is very important to strictly adhere to the basic principles of food handling and hygiene to prevent the possibility of bacterial growth.

LIGHT ONLY SETTING

(BD62SS/2 & BD52B/2 - BD52K/2 - BD52P/2) - When the Multifunction Control (D) is turned clockwise to the LIGHT ONLY setting, the main oven light only will illuminate.

(DQ471/2 & DE47X/2) - When the Main Oven Control (C) is turned clockwise to the  setting, the main oven light only will illuminate.

Main Oven - Conventional Oven

(BD62SS/2 & BD52B/2 - BD52K/2 - BD52P/2)

GB

Important

NEVER line the shelves, the floor or the sides of the oven with aluminium foil as overheating and damage may result.

The oven is heated by elements at the top of the oven and underneath the floor of the oven.

Food should not be placed on the floor of the oven

Operating Procedure

1. Ensure Oven Timer is set to Manual.
2. Position rod shelf as recommended in the chart for food being cooked.
3. Position food centrally under grill element.
4. Turn the selector switch to the conventional oven position.
5. Turn the oven thermostat control to the required temperature setting (see oven temperature charts). The oven light will remain on. The oven indicator light will remain on until the oven reaches the set temperature. This light will then automatically cycle on and off during cooking as the oven temperature is controlled.
6. After use always return both controls to the off position and close the oven door.

Main Oven - Fan Oven (all Models)

GB

Important

NEVER line the shelves, the floor or the sides of the oven with aluminium foil as overheating and damage may result.

The oven is heated by elements at the rear of the oven.

A fan at the rear of the oven operates to circulate heated air within the oven.

Operating Procedure

1. Ensure Oven Timer is set to Manual.
2. - (BD62SS/2 & BD52B/2 - BD52K/2 - BD52P/2)
 - Turn the selector switch to the fan oven position.
 - Turn the oven thermostat control to the required temperature setting (see oven temperature charts).- (DQ471/2 & DE47X/2)
 - Turn the oven thermostat control to the required temperature setting (see oven temperature charts).
3. The oven light will remain on. The oven indicator light will remain on until the oven reaches the set temperature. This light will then automatically cycle on and off during cooking as the oven temperature is controlled.
4. After use always return all controls to the off position and close the oven door.

Main Oven - Fan Oven

Cookery Notes

Since a fan oven heats up more quickly, and generally cooks food at a lower temperature than a conventional oven, pre-heating the oven is often unnecessary. However, foods such as bread, scones, Yorkshire pudding, do benefit from being placed in a pre-heated oven.

The charts are a guide only, giving approximate cooking temperatures and times. To suit personal taste and requirements, it may be necessary to increase or decrease temperatures by 10°C.

Because the fan oven cooks so efficiently, we recommend that when cooking any recipes not designed for a fan oven, you reduce the temperature by about 25°C and the time by about 10 minutes in the hour. If large quantities are being cooked it will be necessary to increase the cooking time somewhat to compensate for the extra oven load.

Unless otherwise indicated in the charts, food is placed in a cold oven, i.e. without preheating. If food is placed in an already hot oven, the suggested cooking time should be reduced, depending on the type and quantity of food being cooked.

It should be noted that at the end of a cooking period there may be a momentary puff of steam when the oven door is opened, this will disperse in a few seconds and is a perfectly normal characteristic of an oven with a good door seal.

Oven Positions

Since the distribution of heat in the fan oven is very even, most foods will cook satisfactorily on any shelf position, but the shelves should be evenly spaced:

To ensure even circulation do not use meat pans larger than 390x300mm (15ins x 12ins) and baking trays no larger than 330 x 255mm (13ins x 10ins), these should be positioned centrally on the oven shelf.

- Do not fit shelves upside down.
- Never use more than 3 shelves in the oven as air circulation will be restricted.
- Food or cooking utensils should not be placed on the floor of the oven. To avoid unnecessary cleaning, rod shelves which are not in use should be removed from the oven.

Main Oven - Fan Oven

Cookery Notes

GB

Temperature and Time

The oven is provided with two shelves. A third is available as an optional extra, contact Genuine Parts and Accessories Hotline (see back page) for further information.

If three shelves are used to cook large quantities of food for home freezing or parties, it may be necessary to increase the cooking times given in the charts by a few minutes, to allow for the loss of heat due to the extra time taken to load the oven, and the larger mass of food.

Baking trays should allow an equal gap on all sides of the oven.

To prepare meat and poultry for Roasting in your Fan Oven

- (a) Wipe the meat or poultry, dry well and weigh it. Meat which has for been stored in a refrigerator should be allowed to come to room temperature before cooking, and frozen meat or poultry must be completely defrosted before placing in the oven.
- (b) The weight of any stuffing used should be added before calculating the cooking time.
- (c) Place meat/poultry in the main oven meat pan supplied with your cooker. Small joints weighing less than 1.75kg (3 1/2 lbs) should be roasted in a smaller meat pan/tin – or they may be 'pot roasted' – a small joint or a large meat pan causes unnecessary oven splashing and evaporation of meat juices.
- (d) Additional fat should not be added, except for veal, very lean meat or poultry which can either be 'larded' with fat bacon or brushed very sparingly with cooking oil or melted fat.
- (e) Beef, lamb, mutton and poultry may be dusted lightly with seasoned flour to give a crisp outer surface. The skin of duck and goose should be pricked to release excess fat during cooking, and the rind of pork should be scored, brushed lightly with oil, and rubbed with salt to give crisp crackling.
- (f) Meat and poultry wrapped in, or covered with a tent of aluminium foil will be juicy and tender. Roasting bags offer the same advantages. Always follow the manufacturer's pack instructions, and remember to reduce the temperatures given for conventional ovens by approximately 25°C and the time by approximately 10 minutes per hour.
- (g) Potatoes for roasting only require to be brushed with cooking oil or melted fat.
- (h) It is not necessary to baste when roasting in an electric oven and stock or liquid should not be added to the meat pan since this only causes unnecessary soiling, steam and condensation.

Frozen Meat and Poultry

Joints of meat and whole birds should be defrosted slowly, preferably in a domestic refrigerator (allowing 5-6 hours per 450g, 1 lb), or at room temperature (allowing 2-3 hours per 450g, 1 lb).

Frozen meat or poultry must be completely defrosted before placing in the oven.

It is essential to wash thoroughly and cook meat and poultry immediately after defrosting.

Main Oven Temperature Chart



GB

Conventional Oven (BD62SS/2 & BD52B/2 - BD52K/2 - BD52P/2)				
It is not necessary to pre-heat the fan oven before roasting. Note: Where times are stated, they are approximate only.				
Meat	Pre-heat	Temperature °C	Time (approx.)	Position in Oven
Beef/ Lamb (slow roasting)	Yes	170/180	35 mins per 450g (1lb) + 35 mins over.	Runner 2 or 3 from bottom of oven.
Beef/ Lamb (foil covered)	Yes	190/200	35-45 mins per 450g (1lb)	
Pork (slow roasting)	Yes	170/180	40 mins per 450g (1lb) + 40 mins over	
Pork (foil covered)	Yes	190/200	40 mins per 450g (1lb)	
Veal (slow roasting)	Yes	170/180	40-45 mins per 450g (1lb) + 40 mins over	
Veal (foil covered)	Yes	190/200	40-45 mins per 450g (1lb)	
Poultry/Game (slow roasting)	Yes	170/180	25-30 mins per 450g (1lb) + 25 mins over	
Poultry/Game (foil covered)	Yes	190/200	25-30 mins per 450g (1lb)	
Casserole Cooking	Yes	150	2-2½ hrs	
If using aluminium foil, never: 1.Allow foil to touch sides of oven. 2.Cover oven interior with foil. 3.Cover shelves with foil.				

Fan Oven (BD62SS/2 & BD52B/2 - BD52K/2 - BD52P/2)			
It is not necessary to pre-heat the fan oven before roasting. Note: Where times are stated, they are approximate only.			
Meat	Pre-heat	Temperature °C	Time (approx.)
Beef	No	160/180	20-25 mins per 450g (1lb) + 20 mins extra.
Lamb	No	160/180	20-30 mins per 450g (1lb) +25 mins extra.
Pork	No	160/180	25-30 mins per 450g (1lb) +25 mins extra.
Veal	No	160/170	25-30 mins per 450g (1lb) +25 mins extra.
Chicken/Turkey up to 4kg (8lb)	No	160/180	18-20 mins per 450g (1lb) + 20 mins extra.
Turkey 4 to 5.5kg (8 to 12lb)	No	150/160 or 150	12-14 mins per 450g (1lb) at plus 12 mins extra *For every 450g (1lb) over 5.5kg (12lb) allow 10 mins per 450g (1lb) and roast at 150°C
Casserole Cooking	No	140-150	1½ - 2 hrs
If using aluminium foil, never: 1.Allow foil to touch sides of oven. 2.Cover oven interior with foil. 3.Cover shelves with foil.			

The most accurate method of testing the readiness of joints of meat or whole poultry is to insert a meat thermometer into the thickest part of a joint, or the thickest part of poultry thighs, during the cooking period. The meat thermometer will indicate when the required internal temp has been reached.

Beef -	Rare: 60°C	Lamb: 80°C	Poultry: 90°C
	Medium: 70°C	Pork: 90°C	
	Well Done: 75°C	Veal: 75°C	

Main Oven Temperature Chart

GB

Baking	Conventional Oven (BD62SS/2 & BD52B/2 - BD52K/2 - BD52P/2)			
Food	Pre-heat	Temperature °C	Time in mins.	Shelf Position
Scones	Yes	220/230	10-15	2nd from bottom
Small Cakes	Yes	180/190	15-25	3rd from bottom
Victoria Sandwich	Yes	160/170	20-30	3rd from bottom
Sponge Sandwich (fatless)	Yes	170/180	15-20	3rd from bottom
Swiss Roll	Yes	190/200	8-12	3rd from bottom
Semi-rich Fruit cakes	Yes	150/160	1¼ hrs. 7"	2nd from bottom
Rich Fruit Cakes	Yes	130/140	Depending on recipe and size	2nd from bottom
Shortcrust Pastry	Yes	180/190	Depending on use	2nd or 3rd from bottom
Puff Pastry	Yes	190/200	Depending on use	2nd or 3rd from bottom
Yorkshire Pudding	Yes	190/200	40-45	3rd from bottom
Individual Yorkshire Pudding	Yes	200/210	20-30	3rd from bottom
Milk Pudding	Yes	140/150	1¼ - 2 hrs.	2nd from bottom
Baked Custard	Yes	130/140	40-50	3rd from bottom
Bread	Yes	190/200	25-35	3rd from bottom
Meringues	Yes	80/90	3 - 3½ hrs.	3rd from bottom

Baking	Fan Oven (BD62SS/2 & BD52B/2 - BD52K/2 - BD52P/2)		
Food	Pre-heat	Temperature °C	Time in mins.
Scones	Yes	210/220	9-12 approx.
Small Cakes	No	170/180	15-25 approx.
Victoria Sandwich	No	160/170	20-30 approx.
Sponge Sandwich (fatless)	Yes	180/190	15-20 approx.
Swiss Roll	Yes	190/200	12-15 approx.
Semi-rich Fruit cakes	No	140/150	1¼ - ½ hrs. approx.
Rich Fruit Cakes	No	130/140	Depending on size
Shortcrust Pastry	No	190/200	Depending on size
Puff Pastry	No	190/200	Depending on size
Yorkshire Pudding	Yes	180/190	40-50 approx.
Individual Yorkshire Pudding	Yes	190/200	20-25 approx.
Milk Pudding	No	130/140	1½ - 2 hrs. approx.
Baked Custard	No	140/150	35-45 approx.
Bread	Yes	200/210	30-35 approx.
Meringues	No	80/90	3 - 4 hrs. approx.

Note: If soft tub margarine is used for cake making, we would recommend using the all in one method and to reduce the temperature by 10°C.

Temperatures recommended in this chart refer to cakes made with block margarine or butter only.

Note: Where times are stated, they are approximate only.

Main Oven - Circulaire Roasting



(BD62SS/2 & BD52B/2 - BD52K/2 -
BD52P/2)

CIRCULAIRE ROASTING

Circulaire roasting - food is placed on the roasting rack, this allows the oven fan to circulate the hot air around the food, making it suitable for thin foods, such as chops, steaks, sausages as well as meat joints and poultry, as it will cook both sides at the same time. It is possible to cook on any shelf position, as the temperature in the oven is evenly distributed. Also, the oven heats up more quickly and generally will cook food at a lower temperature than a conventional oven, so pre-heating is not necessary for most foods. For a guide on "cooking times" and "cooking temperatures" see "Circulaire Roasting Chart", next page.

If required, circulaire roasting can be timed using the Oven Timer. Follow the timer instructions before selecting Fan Oven function and the required temperature.

Note: It is also possible to cook food on the roasting rack on one shelf, while cooking different types of food at the same temperature, on other shelf positions (three shelves maximum).

Operating Instructions:

- STEP 1.** Ensure the Oven Timer is set to manual. Ensure that the oven shelf is in the position you require. Place the food centrally on the roasting rack. Position the roasting rack on top of the grill/meat pan. Place the grill/meat pan centrally on the oven shelf. Ensure the oven door is fully closed.
- STEP 2.** Turn the control knob (D) clockwise to the fan oven function. Turn the control knob (C) clockwise and select the required cooking temperature. The pilot light (●) will immediately come on and will remain on until the oven reaches the required temperature. The light will then automatically go off and on during cooking as the oven thermostat maintains the correct temperature.
- STEP 3.** After use, turn controls (C) and (D) to the Off (O) position.

Note: At the end of a cooking period there may be a momentary puff of steam when the door is opened. This will disperse in a few seconds and is a perfectly normal characteristic of an oven with a good door seal.

GB

Main Oven - Circulaire

Roasting Chart

GB

(BD62SS/2 & BD52B/2 - BD52K/2 - BD52P/2)

Type of Meat & Poultry	Temperature °C	Time (approximate)	PLACE FOOD ON ROASTING RACK, THEN POSITION ABOVE THE MEAT PAN.
BEEF Beef - any type of joint	160/180	20-25 minutes per 450g (1lb) + 20 minutes extra	
PORK Pork - any type of joint	160/180	25 minutes per 450g (1lb) + 25 minutes extra	
Pork - Chops	170	30-45 minutes	
LAMB Lamb - any type of joint	160/180	25 minutes per 450g (1lb) + 25 minutes extra	
Lamb - Chops	170	20-30 minutes	
CHICKEN/TURKEY up to 4kg (8lb)	160/180	18-20 minutes per 450g (1lb) + 20 minutes extra	
STEAKS	170	30-45 minutes	
GAMMON STEAKS	170	30-45 minutes	
SAUSAGES	170	30-45 minutes	

Note: The above chart is only a guideline. The times and temperatures may be increased or decreased depending on personal taste.

Using the Main Oven for Other Functions

'S' SLOW COOK SETTING

This is used for slow cooking, keeping food warm and warming plates for short periods.

Extra care should be taken when warming bone china, as it may be damaged in a hot oven.

DO NOT place food or plates directly on the oven floor as this could damage both the oven lining and the plates which are being warmed.

ADVANTAGES OF SLOW COOKING ARE:

The oven stays cleaner because there is less splashing. Timing of food is not as critical, so there is less fear of overcooking. Inexpensive joints of meat are tenderised. Fully loading the oven can be economical. Cooking times can be extended in some cases by up to 2 hours.

OPERATION:

(for models BD62SS/2 & BD52B/2 - BD52K/2 - BD52P/2):

1. Place the prepared food in the main oven and ensure the door is fully closed.
2. Select Slow Cooking Temperature 'S' by turning the Main Oven Temperature Control **(C)** and Multifunction Control **(D)** clockwise to Fan Oven mode.

(for models DQ47I/2 & DE47X/2):

1. Place the prepared food in the main oven and ensure the door is fully closed.
2. Select Slow Cooking Temperature 'S' by turning Main Oven Temperature Control **(C)**.

STORAGE & RE-HEATING OF FOOD:

1. If food is to be frozen or not used immediately, place it in a clean container and cool as soon as possible.
2. Always thaw frozen food completely in the refrigerator before re-heating.
3. Always reheat food thoroughly and ensure it is piping hot before serving.
4. Only re-heat food **once**.

POINTS TO CONSIDER WHEN PREPARING FOOD FOR SLOW COOKING

1. Make sure that the dishes to be used will fit into the oven ensuring enough room for air to circulate.
2. All dishes cooked on the slow setting will require a minimum of 6 hours, however, if they are cooked for 1-2 hours longer then deterioration in their appearance may be noticed.
3. Never cook joints of meat over 2.7kg (6 lb) or poultry over 2.0kg (4lb 8oz). We do not recommend that joints of meat or poultry are stuffed before cooking on the slow setting.
4. To seal in the meat juices, always cook meat or poultry at 170°C for 30 minutes before wrapping in foil and placing on a rack over a tin (to allow good air circulation) before turning the control to the slow setting and cooking immediately.
5. Always ensure that joints of pork and poultry are thoroughly cooked by checking with a meat thermometer before serving.
6. Always thaw frozen foods completely before cooking. We do not recommend placing frozen food in the oven to cook.
7. Always bring soups, liquids and casseroles to the boil before placing in the oven.
8. Ensure that casserole dishes have a good seal (not airtight) and cover to the top with foil to prevent loss of moisture.
9. Ensure that fruit and vegetables are cut into even sized small pieces to cook properly.
10. Always adjust seasoning before serving.
11. If using dried red kidney beans it is important that the beans are soaked and then boiled for a minimum of 10 minutes before using in any dish to destroy any toxins.
12. When cooking fish or egg dishes it may be necessary to check during cooking to avoid overcooking.

Main Oven Grilling

GB

(BD62SS/2 & BD52B/2 - BD52K/2 - BD52P/2)

DO NOT allow young children near the appliance when the grill is in use as the surfaces can get extremely hot.

GRILLING SHOULD NEVER BE UNDERTAKEN WITH THE DOOR CLOSED.

- Do Not line the grill pan with aluminium foil.
- Ensure that the grill pan is cleaned after every use. Excess fat build-up in the bottom of the pan could cause a fire hazard.
- Preheat the grill on the required setting for 5 minutes

Grilling Procedure:

1. Open the main oven door fully and position the rod shelf as recommended in the grilling chart (see below) for the food being cooked.
2. Turn the multifunction selector switch to HALF grill or FULL grill and then turn the Main Oven temperature control to the required setting to pre-heat for approximately 5 minutes.
3. Position the grill pan centrally under the grill element and push back as far as the location stops on the rod shelf.
4. Leave the oven thermostat at setting MAX for toast and for fast cooking of foods. For thicker foods requiring longer cooking turn the thermostat to a lower setting, after initial sealing on both sides at MAX. The thicker the food, the lower the thermostat should be set. If excessive smoke is emitted, reduce the setting.
5. After use always return both controls to their OFF (O) position.

Food	Shelf Position from base of oven	Setting Required Temp °C	Cooking Time
Toasting of bread products	6	MAX	2-5 mins
Small cuts of meat, sausages, bacon etc.	5 or 6	MAX for 4- 6 mins then reduce to setting 170	10-20 mins
Chips, gammon steaks etc.	5	MAX for 4- 6 mins then reduce to setting 170	20-30 mins
Fish: Whole / Fillets	5	170	15-20 mins
Fingers	6	MAX	10-15 mins
Pizza's	5	170	10-15 mins
Browning of food	5	MAX	5-10 mins

Warning: Before cleaning, please ensure that the electricity supply to the appliance is switched off and the appliance is fully cold.

! Never use steam cleaners or pressure cleaners on the appliance.

! Clean the glass part of the oven door using a sponge and a non-abrasive cleaning product, then dry thoroughly with a soft cloth. Do not use rough abrasive material or sharp metal scrapers as these could scratch the surface and cause the glass to crack.

! The accessories can be washed like everyday crockery (even in your dishwasher).

1. "STAYCLEAN" OVEN LINERS (Top Oven Sides, Main Oven Sides and Rear Panel)

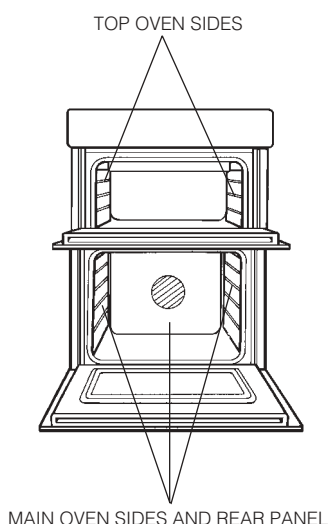

(a) How "Stayclean" works.

The surfaces of the "Stayclean" oven liners (Main Oven rear panel) are treated with a special vitreous enamel which absorbs cooking soils. At temperatures of 220°C (425°F) or above, the special surface enables these soils to be slowly destroyed. The higher the temperature the more effective it is.

(b) Cleaning.

In most cases normal cooking operations at 220°C (425°F) will permit this cleaning operation to proceed during cooking. However if higher cooking temperatures are not used regularly, it may be necessary, in order to prevent heavy soiling, to run the ovens without shelves or meat pan, at a maximum setting for a couple of hours (Fan Oven mode only).

It should not normally be necessary to clean the "Stayclean" panels with water. If the user feels it is desirable to do so, wipe them over with a clean, soapy cloth, followed by a wipe with a clean damp cloth.

DO NOT use biological washing powder, harsh abrasives or chemical oven cleaners of any kind as this could damage the "Stayclean" oven liners.

2. CLEANING GRILL, TOP OVEN AND MAIN OVEN

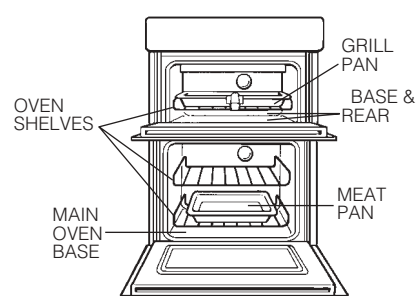

(a) Base & Rear of Top Oven and Base of Main Oven.

Wipe out the oven with a damp soapy cloth. For more stubborn stains on the base of the oven use a well soaped fine steel wool soap pad.

(b) Grill Pan, Meat Pan & Oven Shelves.

To prevent stains from being burnt on to the grill pan, food support and rod shelf, always wash immediately after use in warm soapy water. Use a well soaped fine steel wool soap pad to remove stubborn stains from the rod shelves, grill pan, meat pan and the base of the oven.

DO NOT use aerosol cleaners on this oven as they could adversely affect the fan motor unit, and cannot be wiped off the fan blade.

(c) Solarplus Grill.

To clean the Solarplus Grill, use a clean, damp, soapy cloth and wipe over. If stubborn stains remain, gently clean with a well soaped nylon scouring pad and wipe over with a damp cloth.

DO NOT use metal cleaning utensils, wire wool or proprietary oven cleaners on the grill element mesh.

Care and Cleaning

GB

3. OVEN DOORS

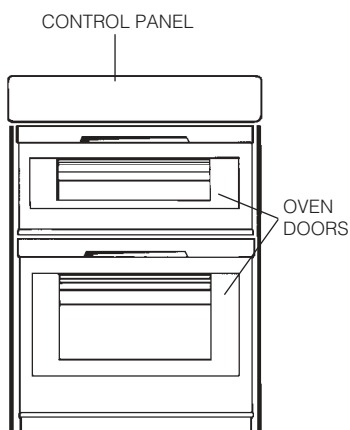

(a) Control Panel

Regularly wipe with a clean, damp cloth and polish with a clean, dry cloth.

(b) Inner Door Panels & Glass

Open the door fully. The glass panel may now be washed. Stubborn stains can be removed by using a well soaped, fine steel wool soap pad.

(c) Stainless trims (BD62SS/2 & DE47X/2 only)

Regularly wipe with a clean, damp cloth and polish with a clean dry cloth.

DO NOT use scouring pads, or abrasive powder, which will scratch the glass.

4. REPLACEMENT OF THE OVEN LAMP

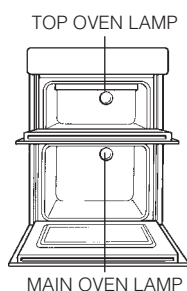

Warning: To avoid electric shocks - please ensure that the electricity supply to the appliance is switched off and the appliance is fully cold, before removing the lamp lens.

Open the oven door and remove the oven shelves. Using a thick cloth, grip the lamp lens, unscrew anticlockwise and remove the lens. Carefully unscrew the bulb anti-clockwise. Fit replacement bulb (25W 300°C SES) and refit lens.

5. HOW TO CLEAN THE LAMP LENS

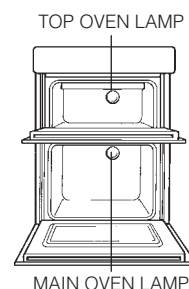

Warning: To avoid electric shocks - please ensure that the electricity supply to the appliance is switched off and the appliance is fully cold, before cleaning lamp lens.

Open the oven door and remove the oven shelves. Using a thick cloth, grip the lamp lens, unscrew anticlockwise and remove. Clean with a non-abrasive cleansing cream and refit lamp lens.

DO NOT use scouring pads, or abrasive powder, which will scratch the glass lens

(BD62SS/2 & BD52B/2 - BD52K/2 - BD52P/2)

Take particular care not to damage the inner surface of the door inner glass that is coated with a heat reflective layer. Do not use scouring pads, or abrasive powder, which will scratch the glass. Ensure that the glass panel is not subjected to any sharp mechanical blows.

Stubborn stains can be removed by using a fine steel wool pad. For slight soiling the inner glass panel may be cleaned, while still warm, without removing it from the door. After cleaning, rinse and dry with a soft cloth.

CLEANING THE DOORS

SIDE OPENING DOORS

Cleaning the door glass is the same as the drop down doors, except take care to support the weight of the inner glass when removing and refitting.

DROP DOWN DOORS

Remove the door inner glass as follows.

1. Open the door fully and unscrew the two screws securing the glass panel so that the securing brackets can be turned. There is no need to remove the screws completely.

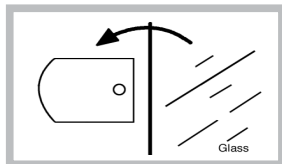

2. Turn the brackets so that the glass can be removed and cleaned at the sink (Fig. 1.).
3. The inside of the outer door glass can now be cleaned while still fitted to the cooker.

NEVER OPERATE THE COOKER WITHOUT THE INNER DOOR GLASS IN POSITION.

Refit the door inner glass as follows.

1. **NOTE:** The inner door glass has a special reflective coating on one side. Replace the door inner glass so that the s t a t e m e n t :

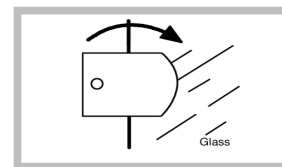

"IMPORTANT THIS FACE TOWARDS THE OVEN" can be read from the inner side of the door.

2. Turn the two securing brackets back to their original position to retain the glass and tighten the screws (Fig. 2.)

Care and Cleaning (DQ47I/2 & DE47X/2)

GB

CLEANING THE DOORS

Take particular care not to damage the inner surface of the door inner glass that is coated with a heat reflective layer. Do not use scouring pads, or abrasive powder, which will scratch the glass. Ensure that the glass panel is not subjected to any sharp mechanical blows.

Stubborn stains can be removed by using a fine steel wool soap pad. For slight soiling the inner glass panel may be cleaned, while still warm, without removing it from the door. After cleaning, rinse and dry with a soft cloth.

DROP DOWN DOORS

Remove the door inner glass as follows.

1. Open the door fully and remove the extrusion end caps (This should be done by hand but if it proves too difficult, simply lift the inner glass to ease the end caps out of position).

NOTE: If you need to use a tool - be careful not to damage the extrusion or end cap.

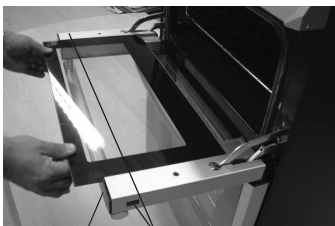

Top filler cap Remove both screws to
remove top filler cap

2. Carefully slide the inner glass towards you and withdraw it from its locating slots. Ensure that the door is not allowed to slam shut, due to the reduction in door weight. Clean the glass as described above.
3. The inside of the outer door glass can now be cleaned while still fitted to the cooker.

NEVER OPERATE THE COOKER WITHOUT THE INNER DOOR GLASS IN POSITION.

Refit the door inner glass as follows.

1. Open the door fully.
2. Locate the inner door glass into its slots. The inner door glass has a special reflective coating on one side, in order to minimise surface temperatures and energy consumption during use, it is important it is fitted correctly.
3. Carefully slide the glass into its slots as far as it will go and replace the top filler cap.

Electrical Requirements

For your own safety, we recommend that your cooker is installed by a competent person such as one who is registered with NICEIC (National Inspection Council for Electrical Installation Contracting). The cooker should be installed in accordance with the latest edition of the IEE Regulations.

Warning: This appliance must be earthed.

Electrical Connections

The installer must check that the voltage shown on the rating plate corresponds with the house electricity supply. The cooker must be supplied via a suitable double pole isolating switch, having a contact separation of at least 3mm in all poles placed in a readily accessible position adjacent to the cooker. If the cooker is to be wired into a connector unit, this may be positioned behind the cooker providing the following requirements are met:

- i) The connector unit must not project from the wall more than 25mm.
- ii) The top of the connector must not be more than 130mm above floor level.

Remove the terminal cover at the rear base of the cooker. Pass the cable through the cable clamp and connect to the appropriate terminals provided. Allow sufficient cable for any future servicing. Tighten the screws on the cable clamp and replace the cover. Make main connections in the connector unit or cooker control unit. This appliance conforms to B.S. EN 55014 regarding suppression of Radio and Television reception interference.

A double Pole control switch having a minimum rating of 32 amps should be used to feed the cooker using a suitably rated cable. Where a hob is fitted adjacent to or over the cooker, a 45 amp Double Pole control switch should be used to feed both units via separate suitably rated cables.

We recommend a minimum of 4mm² PVC insulated twin and earth cable conforming to B.S. 6004 for connection of each appliance.

In all cases adhere to routing details (see fig. 4).

This appliance must not be installed over any other appliance that generates heat such as a plinth heater.

Note: Due to many different types of installation, a mains cable is not supplied with this product. The installer will fit the correct type and length of cable.

Important

It is essential that the lower cupboard is constructed in the manner illustrated i.e. having side, back, and roof panels so joined as to provide no apertures which could permit access to the oven unit when installed.

1. General

The appliance is designed for mounting at a safe level into an oven housing which must be secured to the backing wall.

2. Ventilation

- a. The oven housing unit cabinet dimensions must comply with fig. 4.
- b. An air gap of 50mm minimum must be provided at the rear of any top or bottom cupboards or shelves (see fig. 1).
- c. It is necessary that the cabinets are provided with unobstructed ventilation, i.e. from adjacent cabinetry. This can be done by either raising the base of the cabinets using the adjusting feet (or spacers) or alternatively by providing a slot in the cabinet plinth to the dimensions in fig. 1.
- d. The air gap at rear allows the warmed air to pass out of the inner cabinet space. Where it is intended to fit cupboards above the oven unit to ceiling height, it is essential that the warmed air is exhausted through the front of the cabinet (see fig. 1).
- e. If an oven unit is installed adjacent to a tall cabinet, steam escaping from the oven when the door is opened could condense on and maybe stain the adjacent surface. To prevent permanent staining, the adjacent surface should be made of a material that is heat resisting and easy to clean. Adjacent tall cabinets should not be deeper than the oven housing cabinet.

3. Final Installation

- a. Using a spirit level, check that the housing cabinet is level from side to side and from front to back in its installed position.
- b. Correct any unevenness by placing spacers under the bottom of the cabinet. Make sure that the cabinet rests firmly on the floor without rocking.
- c. Before the oven is fitted, the cabinet must be firmly secured to the backing wall for stability.
- d. The oven unit should now be lifted (this is a two person lift) into the cabinet and pushed fully home.
- e. Finally, the oven is secured to the cabinet by means of the four Phillips C/SK Head screws - two through each side trim.
- f. Remove all packaging material from the grill and oven interior.

List of loose items:

4 x Phillips C/SK Head No. 6 x 25mm screws.

Tall Cabinet Ventilation

GB

Fig. 1

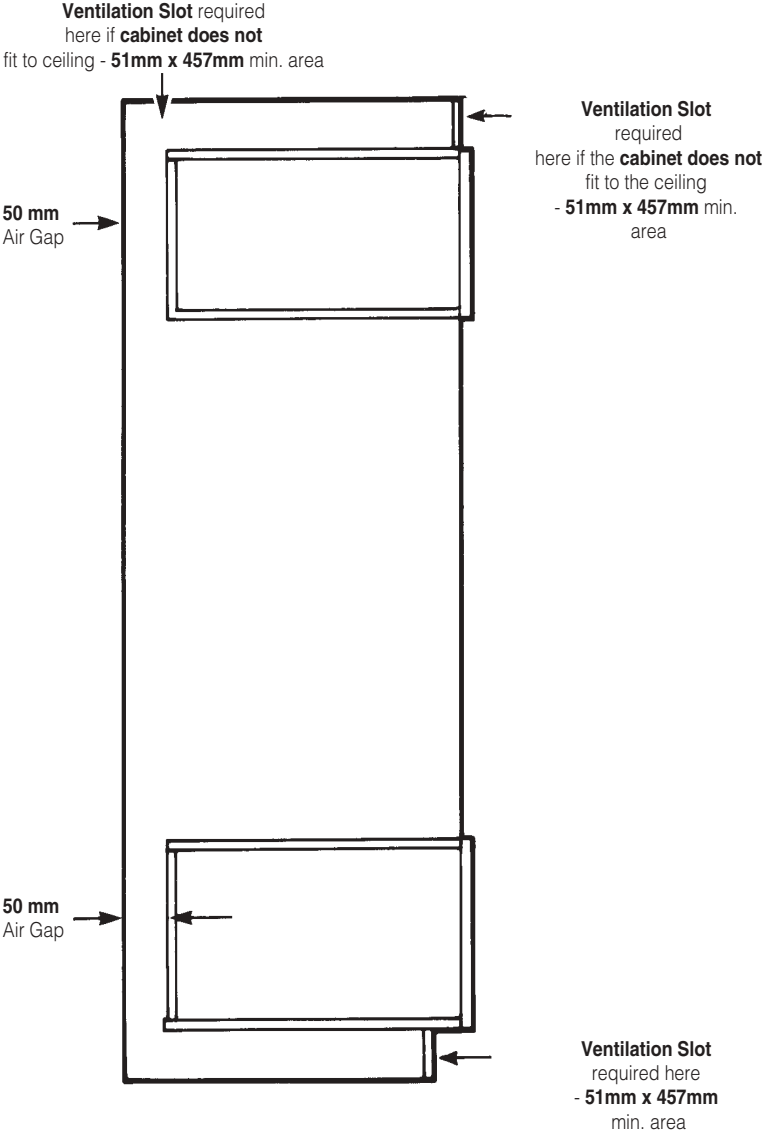

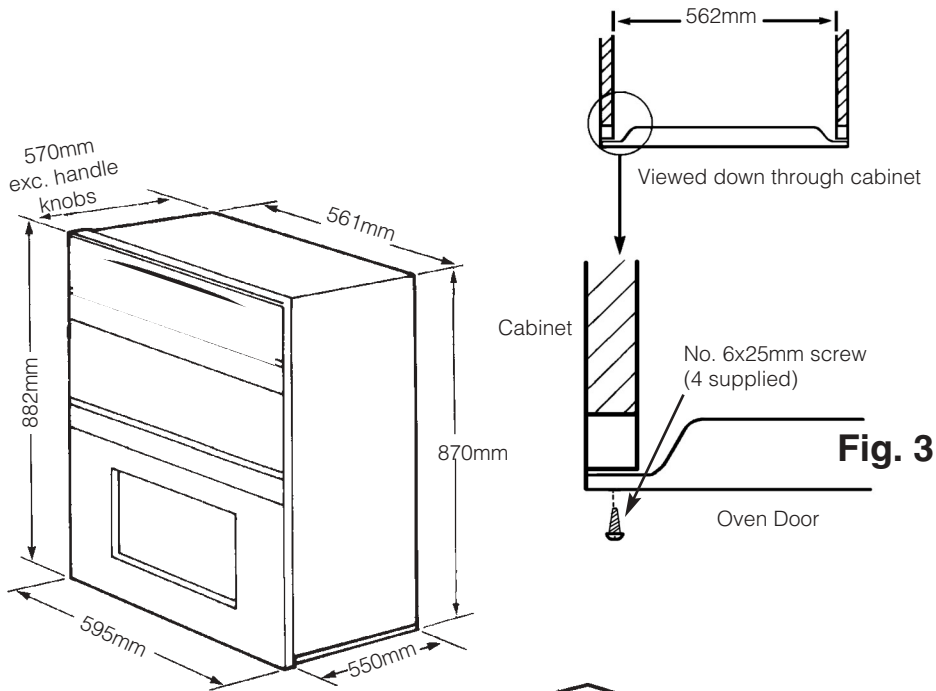

Fig. 2

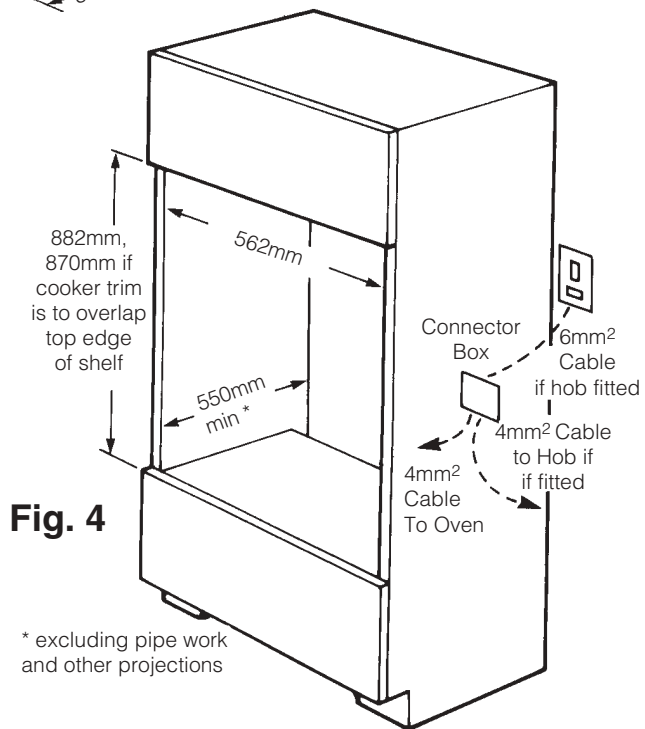

Fig. 4

If something goes wrong...

GB

Before calling a Service Engineer, please check through the following lists.
THERE MAY BE NOTHING WRONG.

Problem	Check
Slight odour or small amount of smoke when grill / oven used for first time	This is normal and should cease after a short period.
Nothing works	If you find that the timer display is blank, then it is likely that there is no electricity supply to your oven. Check: (i) That the main cooker wall is switched on (ii) Other appliances, to see if you have had a power cut (iii) The main circuit breaker for the property
Timer Display shows '0.00' with "Auto" Flashing	The power supply to your oven has possibly been interrupted, but has now come back on again. Reset the timer to the correct day and "Manual" operation using the instructions given in the timer section of the book.
Main oven and Top ovens do not work, but the grill works	Your timer may be set for an Auto Cooking programme: Check the timer to see whether 'Auto' is lit or flashing. If it is then please follow the instructions given in the Timer section of this book to return the timer to Manual operation.
Top oven and grill do not work, but Main oven works.	Operating the cooker under the following conditions may cause a safety device to operate: (a) Grilling with the door closed - Always grill with the door fully open (b) Grilling for an excessively long period at maximum setting - see Grilling guide. Switch off appliance and allow to cool for approx 30 mins. Switch the cooker back on and check that the Grill / Top oven is now operating.
Grill keeps turning on and off	When the Grill control is operating at less than its maximum setting, the Grill will cycle on and off, this is normal and <u>not</u> a fault.
Timer buzzer / audible tone operates continually	To cancel the audible tone, press the minute minder button.
Oven temperatures too high or low	Check temperature and shelf positions are as recommended in the Oven Temperature Charts. It may be necessary to increase or decrease the recommended temperature slightly to suit your taste.
Oven does not cook evenly	Check: (a) Temperature and shelf positions are as recommended in the Oven Temperature Charts. (b) Oven utensils being used allow sufficient air flow around them.

If something goes wrong...

Problem	Check
Grilling is uneven.	Ensure that Grill pan has been positioned as stated in the Grilling section of this book.
Oven lamp does not work.	The oven lamp is not covered by the guarantee. The part is easily changed (see the section on oven lamp replacement) A new lamp may be obtained from our Genuine Parts & Accessories Hotline (see back page).
Condensation on the wall at the rear of the cooker.	Steam and / or condensation may appear from the vent at the rear of the appliance when using an oven particularly for foods with a high water content e.g. frozen chips, roast chicken etc. This is normal, and any excess should be wiped off.
Steam / Condensation in the oven after use.	Steam is a by - product of cooking any food with a high water content. To help minimise always: a) Try to avoid leaving food in the oven to cool after being cooked. b) Use a covered container, wherever possible.

If you have been through the above list and there is still a problem, contact Service (see back page).

Disposal of your product

To minimise the risk of injury to children please dispose of your product carefully and safely. Remove all doors and lids. Remove the mains cable (where fitted) by cutting off flush with the appliance and always ensure that no plug is left in a condition where it could be connected to the electricity supply.

To help the environment, Local Authority instructions should be followed for the disposal of your product.



Disposal of old electrical appliances

The European Directive 2002/96/EC on Waste Electrical and Electronic Equipment (WEEE), requires that old household electrical appliances must not be disposed of in the normal unsorted municipal waste stream. Old appliances must be collected separately in order to optimise the recovery and recycling of the materials they contain and reduce the impact on human health and the environment.

The crossed out "wheeled bin" symbol on the product reminds you of your obligation, that when you dispose of the appliance it must be separately collected.

Consumers should contact their local authority or retailer for information concerning the correct disposal of their old appliance.

Guarantee

12 months Parts and Labour Guarantee

Your appliance has the benefit of our manufacturer's guarantee, which covers the cost of breakdown repairs for twelve months from the date of purchase.

This gives you the reassurance that if, within that time, your appliance is proven to be defective because of either workmanship or materials, we will, at our discretion, either repair or replace the appliance at no cost to you.

The guarantee is subject to the following conditions:

- The appliance has been installed and operated correctly and in accordance with our operating and maintenance instructions.
- The appliance is only used on the electricity or gas supply printed on the rating plate.
- The appliance has been used for normal domestic purposes only.
- The appliance has not been altered, serviced, maintained, dismantled or otherwise interfered with by any person not authorised by us.
- Any repair work must be undertaken by us or our appointed agent.
- Any parts removed during repair work or any appliance that is replaced become our property.
- The appliance is used in the United Kingdom or Republic of Ireland.

The guarantee does not cover:

- Damage resulting from transportation, improper use, neglect or interference or as a result of improper installation.
- Replacement of any consumable item or accessory. These include but are not limited to: plugs, cables, batteries, light bulbs, fluorescent tubes and starters, covers and filters.
- Replacement of any removable parts made of glass or plastic.

THE GUARANTEE WILL NOT APPLY IF THE APPLIANCE HAS BEEN USED IN COMMERCIAL OR NON-DOMESTIC PREMISES.

5 Year Parts Guarantee

Hotpoint also offers you a FREE 5 year parts guarantee. This additional guarantee is conditional on you registering your appliance with us and the parts being fitted by one of our authorised engineers. There will be a charge for our engineer's time. To activate the extra parts warranty on your appliance, simply call our registration line on **0870 6092094 (ROI 01 230 0800)**

Extended Guarantees

We offer a selection of protection plans that enable you to fully cover yourself against the expense of repair bills for the life of your policy. To find the ideal plan for you please call our advice line on **08709 088 088 (ROI 01 230 0233)**

Free Helpdesk Service

We have a dedicated team who can provide free advice and assistance with your appliance if you experience any technical difficulties within the first 90 days of ownership.

Simply call our Hotpoint Service Hotline on **08709 066 066 (ROI 0818 313 413)** for telephone assistance, or, where necessary, to arrange for an engineer to call.



GB

After Sales Service

No one is better placed to care for your Hotpoint appliance during the course of its working life than us - the manufacturer.

Essential Contact Information

Hotpoint Service

We are the largest service team in the country offering you access to 400 skilled telephone advisors and 1100 fully qualified engineers on call to ensure you receive fast, reliable, local service.

UK: 08709 066 066

Republic of Ireland: 0818 313 413

www.hotpoint.co.uk

Please note: Our advisors will require the following information:

Model number

Serial number

Parts & Accessories

We supply a full range of genuine replacement parts as well as accessory products that protect and hygienically clean your appliance to keep it looking good and functioning efficiently throughout its life.

UK: 08709 077 077

Republic of Ireland: 0818 313 413

www.hotpointservice.co.uk

Appliance Registration

We want to give you additional benefits of Hotpoint ownership. To activate your FREE 5 year parts guarantee you must register your appliance with us.

UK 0870 6092094

Republic of Ireland: 01 230 0800

www.hotpointservice.co.uk

As part of Hotpoint's continued commitment to helping the environment, Hotpoint reserves the right to use quality, recycled components to keep down customer costs and minimise material wastage.

GB